

REV	DESCRIPTION	DATE	APPROVED
A	新版发行	2025.08.20	HHM

SPECIFICATION:

- ELECTRICAL:
 - CURRENT RATING:5A;
 - CONTACT RESISTANCE:40mΩ Max;
 - DIELECTRIC WITHSTANDING VOLTAGE:100V AC;
 - INSULATION RESISTANCE:100 MΩ MIN;
- MECHANICAL:
 - MATING FORCE:5~20N;
 - UNMATING FORCE:8~20N;
 - DURABILITY:10000 CYCLES;6~20N AFTER DURABILITY TEST;
- MATERIAL:
 - HOUSING&MOLDING: LCP WHITE UL94V-0;
 - TERMINAL:C7025 T=0.15mm;
 - SHELL:SUS304 T=0.30mm;
 - MID PLATE:SUS304 T=0.20mm;
- PLATING SPECIFICATION:
 - TERMINAL:CONTACT POINT GOLD PLATED 3u"Min
PIN WELDING AREA GOLD PLATED 1u"Min.
 - NI 40u"Min. UNDER PLATED OVER ALL.
 - SHELL:PLATED Ni 50u"Min(Salt spray 48H)
- ELECTROPLATED PRODUCTS NEED TO UNDERGO TIN ADHESION TESTING: THE TIN ADHESION AREA SHOULD REACH OVER 95%.
- SMT REFLOW SOLDERING (PEAK VALUE 260 ° C ± 5 ° C) SHALL BE FREE OF BLISTERING, GLUE MELTING AND POOR COLOR CHANGE (DEFORMATION WITHIN TOLERANCE)
- OPERATING TEMPERATURE: -40° C~+85° C

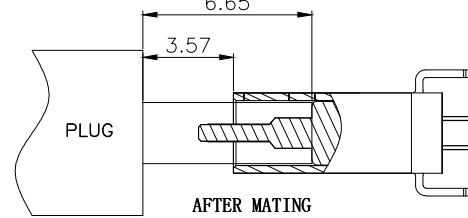

A1	GND	B12	GND
A4	VBUS	B9	VBUS
A5	CC1	B7	D-
A6	D+	B6	D+
A7	D-	B5	CC2
A9	VBUS	B4	VBUS
A12	GND	B1	GND
PIN	SIGNAL NAME	PIN	SIGNAL NAME

CUSTOMER DRAWING		
UNITS mm	SCALE 1:1	SHEET 1 OF 2
PROJECTION: 	DRAW: DAP	
GENERAL TOLERANCE .000 ±0.15 .00 ±0.20 .0 ±0.25 .0 ±2° .00 ±1°	CHECK: HWT	MAT'L SEE TABLE
	APPD: HHM	DWG. NO. A031414A
		PART NO. _____
		SIZE A4

铭创科技(东莞)有限公司
Mingchuang Technology (Dongguan) Co., Ltd.

TITLE
TYPE C母座14PIN 立式四脚插版SMT L=8.2 A款 舌片外露



REV	DESCRIPTION	DATE	APPROVED
A	新版发行	2025. 08. 20	HHM

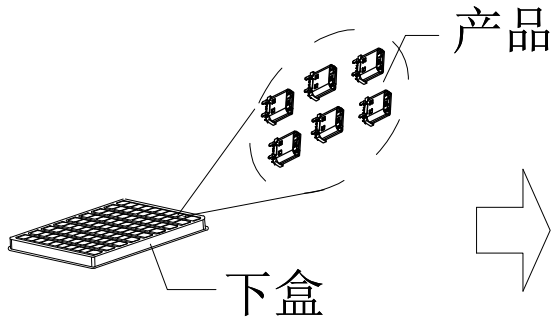

① PE真空盒 (1Set).

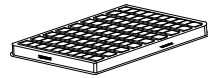

② 100Pcs/盒

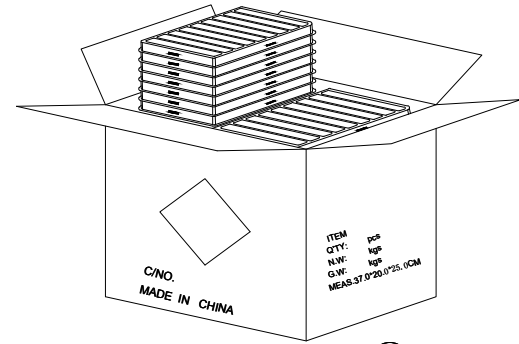

③ 80盒/箱 (8k).

外箱物料标签

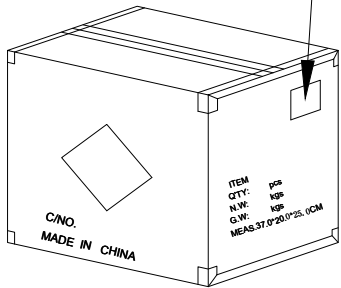

⑥ 依图示粘贴产品或RoHS标签.

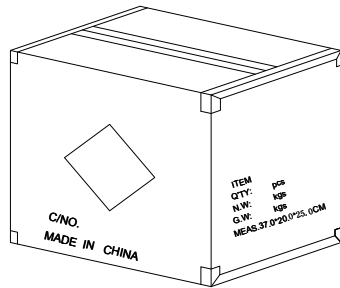

⑤ 外箱用透明胶纸带封“工”字型.

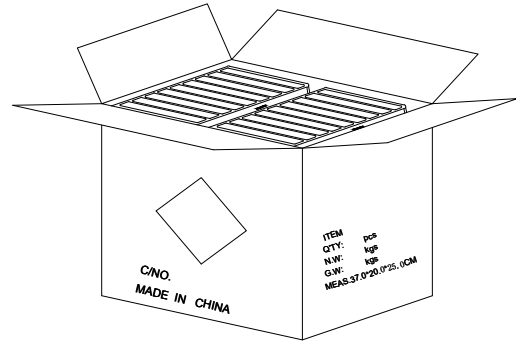

④ 每箱竖放20盒*4, 若尾数箱在空间处加装填充物.

03	纸箱	B-05-0006	370mm*200mm*250mm	1 PCS
02	下盒	B-01-0004	PET透明 TO. 3*L195*W175*H9.5mm	100 PCS
01	连接器	A031414A	14PIN, DIP	8000 PCS
序号	物料名称	物料编号	规格	描述

CUSTOMER DRAWING			铭创科技 (东莞) 有限公司 Mingchuang Technology (Dongguan) Co., Ltd.		
UNITS mm	SCALE 1:1	SHEET 2 OF 2	TITLE TYPE C母座14PIN 立式四脚插版SMT L=8.2 A款 舌片 外露		
PROJECTION: 		DRAW: DAP	MAT'L SEE TABLE		
GENERAL TOLERANCE .000 ±0.15 .00 ±0.20 .0 ±0.25 .0 ±2° .00 ±1°		CHECK: HWT	FINISH SEE TABLE		
		APPD: HHM	DWG. NO. A031414A	PART NO. _____	SIZE A4